

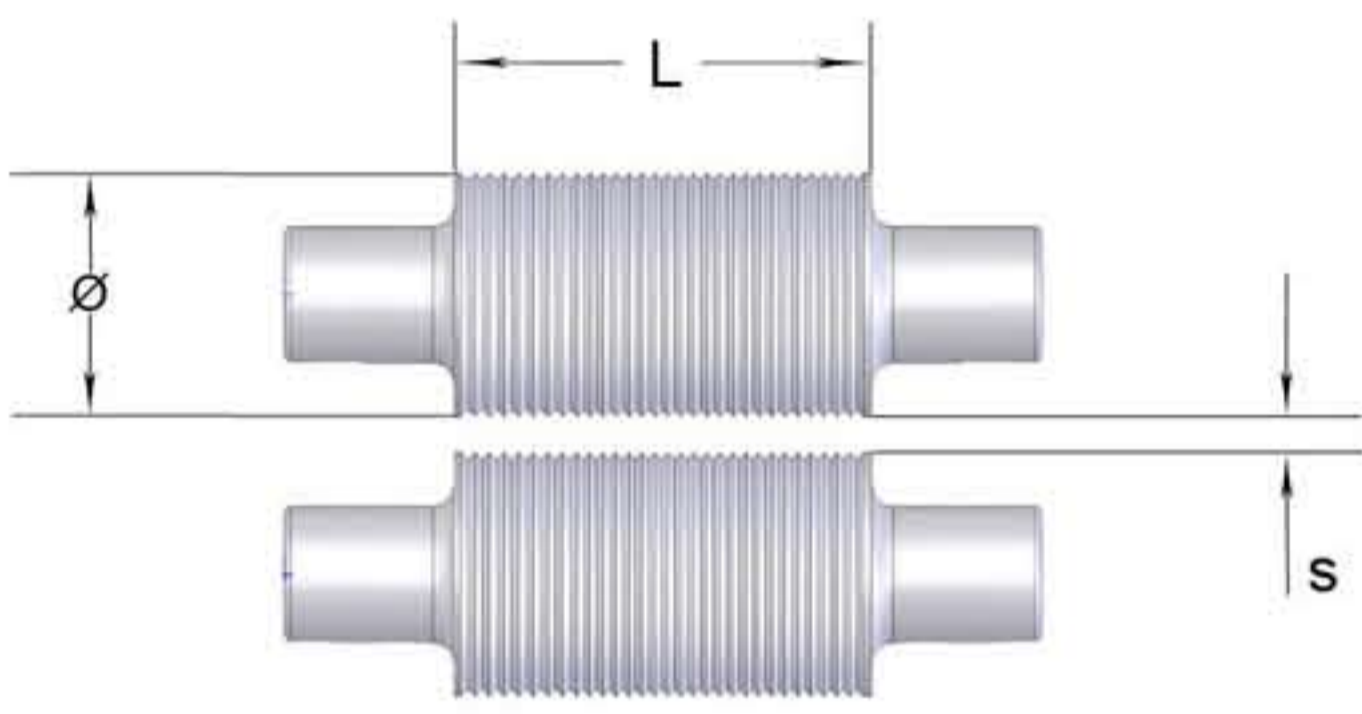

| | L | Ø | s | W |
|--------|-----|-----|----|----|
| MWF160 | 160 | 120 | 30 | 90 |
| MWF180 | 180 | 120 | 30 | 90 |

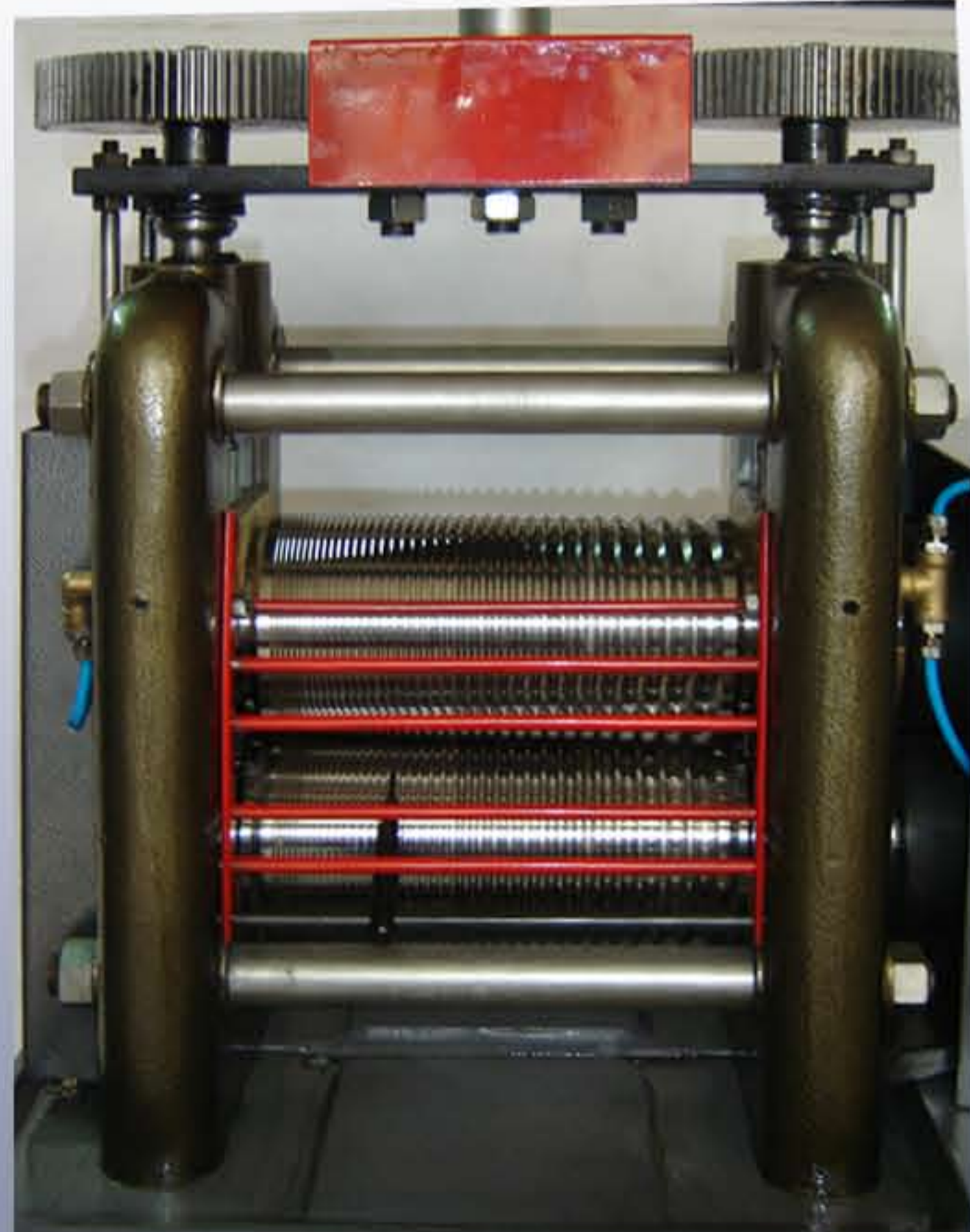

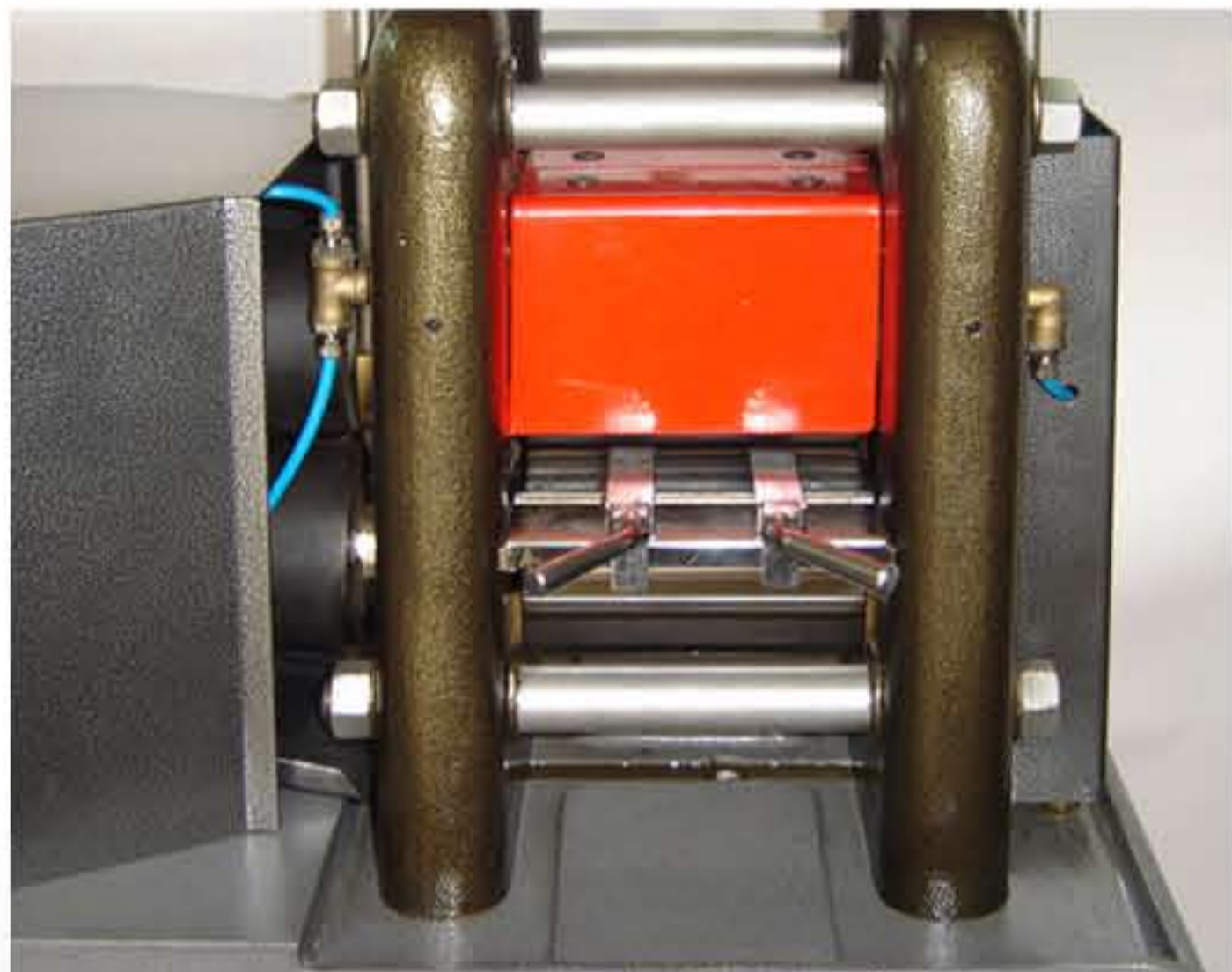

| | L | Ø | ◇◇ | s |
|-------------|-----|-----|--------|----|
| MWF180-160 | 260 | 120 | 12-0.9 | 30 |
| MWF180-160* | 260 | 120 | 9.3-1 | 30 |

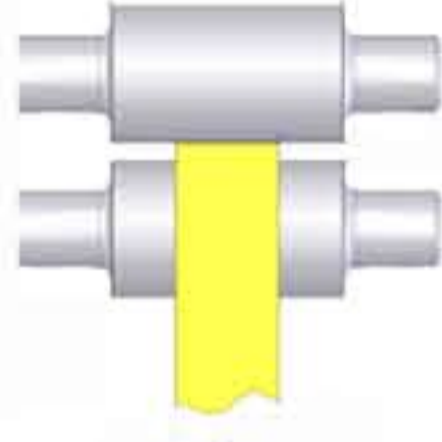

Code Kod EWF

| | | | |
|---|---------------------------|------------------------------|---|
|  | Rollers diameter | Merdanelerin çapı | 120 mm |
| | Rollers width for plate | Düz merdane genişliği | 160/180 mm |
| | Maximum rolling thickness | Maksimum haddeleme kalınlığı | 30 mm |
| | Maximum rolling width | Maksimum haddeleme genişliği | 90 mm |
|  | Rollers width for wire | Tel merdane genişliği | 236 mm |
| | Soft reduction | Yumuşak geçişli kapılar | 9.3 - 1 mm |
| | Standart reduction | Standart geçişli kapılar | 12 - 0.9 mm |
| | Rollers hardness | Merdanelerin sertliği | 62-64 HRC |
| | Roulettes | Desen makarası |  |



| | | |
|-------------------------|-----------------------|---|
| Lubrication system | Yağlama sistemi |  |
| Internal cooling system | İçten soğutma sistemi |  |



| | | |
|------------------|------------|------------------|
| Electrical power | Motor gücü | 5.5 kW |
| Voltage | Gerilim | 380V three phase |



| | | |
|--|--|---|
| Variable frequency control device, Emergency stop, Electrical breaking system and Digital speedometer. | Hız kontrol cihazı, Acil stop Elektrikli firen sistemi ve Dijital hız göstergesi |  |
|--|--|---|



| | | |
|-----------------------------|------------------|----------------------------|
| Transmission to the rollers | Kaplin sistemi | Double oldham/Çift çıkışlı |
| Gears | Dişliler | Hardened/Sertleştirilmiş |
| Winding reels | Sarma makaraları | Optional/Opsiyonel |

| | | | |
|--------|-----------------------|---------------------|--------------------------|
| XYZ, G | Dimensions and weight | Boyutlar ve ağırlık | 150 x 50 x 140 cm 1100kg |
|--------|-----------------------|---------------------|--------------------------|